

HEAVY DUTY RETRACTABLE SHELVING SYSTEM SERIES "AR"

This shelving system accommodates normal and full extension shelves and is especially designed for the storage of heavy items, such as dies, motors and moulds, jigs & fixtures, etc., requiring overhead handling cranes.

Items stored on this shelving system can be picked and re-placed safely, quickly and easily.



STANDARD COLOURS

GREEN RAL 6011

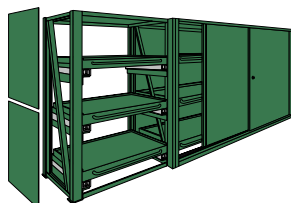

BLUE RAL 5012

GREY RAL 7000

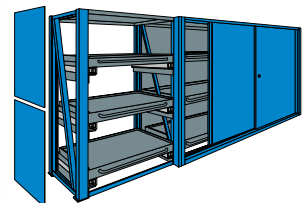



RETRACTABLE SHELVING SYSTEM

The "AR" Shelving system is easy to assemble. The two uprights are bolted to the top shelf. Horizontal tie bars are fitted to the lower end of the upright. This procedure is also followed if additional parts are fitted.

The retractable shelves can be fitted with normal extension guide rails to take 800 kg load capacity as well as full extension telescopic guide rails allowing 1000 kg load capacity. The retractable shelves are height adjustable in increments of 50 mm pitch.

SAFETY REGULATIONS

The development and design of this shelving system is based on the latest safety standards and requirements. To ensure absolute safety, the shelving system comprises the following characteristics:

FLOOR SUPPORT PLATE

The floor support plate distributes the weight pressure imposed by the upright onto the floor surface.

A technical chart showing flooring and surface requirements is supplied by FAMI.

FIXING HOLES

The floor support plate has a fixing hole to allow anchorage to the floor with raw bolts supplied as a standard. "Floor fixing" forms part of the basic safety requirements.

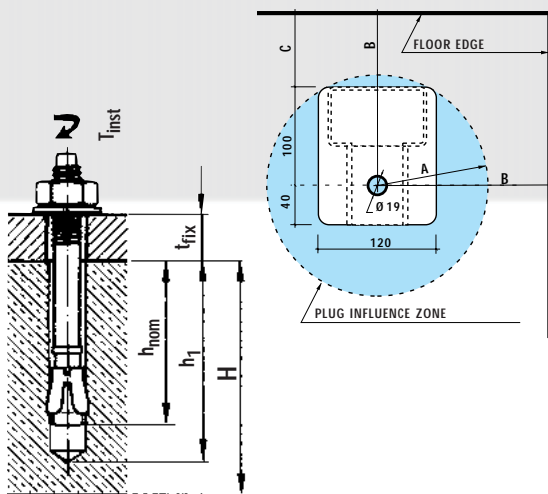

Recommended raw bolt tension	11,65 kN
Raw bolt diameter	Ø 16 mm
Hole diameter in concrete	Ø 16 mm
Minimum hole depth	h_1 115 mm
Minimum fitting depth	h_{nom} 95 mm
Max. fixable thickness	t_{fix} 25 mm
Max torque setting	T_{inst} 125 NM
Min. surface thickness for raw bolt fixing*	H: 160 mm
Min. distance of raw bolt from surface edge	B: 175 mm
Raw bolt influence area or centre distance **	A: 112,5 mm
Min. distance of upright from surface edge	C: 75 mm

* It is compulsory that the floor surface has sufficient strength to maintain the shelving weight and floor pressure. The surface must be of sufficient strength to allow for raw bolts to be fitted to the floor.
 ** The area must remain free of any other force.



DOUBLE LOCKING SAFETY MECHANISM

The shelving system is fitted with a double locking system to allow only one shelf to be pulled out at any one time. The anti-tilt system is based on a bar with safety catches fitted to each upright.

Each shelf is fitted with an individual safety catch.

The anti-tilt system prevents the movement of any stored items.



RETRACTABLE SHELF CATCH

The safety catch locks the shelf into normal or retracted position.

This feature prevents the movement of the shelf during handling of stored items.



Catch for normal extension shelves



Catch for full extension shelves

LOAD CAPACITY PER SINGLE BAY

The shelving system is supplied with a weight loading table to ensure correct loading.

The table indicates:

- the type of shelving
- the year of manufacture
- manufacturer's internal reference number
- load capacity per bay excluding bay weight.

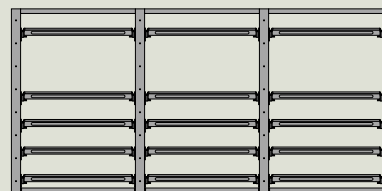

B A Y

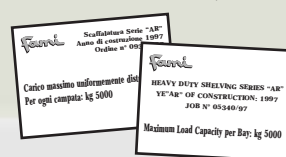

SHELF LOAD CAPACITY

A label stating load capacity for evenly distributed weight is fitted to each shelf.

INSTALLATION INSTRUCTION BOOKLET

The shelving system is supplied with installation/maintenance instructions. The installation/maintenance instructions must be followed to ensure correct operation of the shelving system.

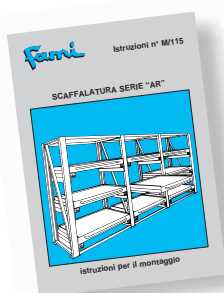



RETRACTABLE SHELVING SYSTEM

New

"AR" Shelving System
Technical Data

**NORMAL
EXTENSION**

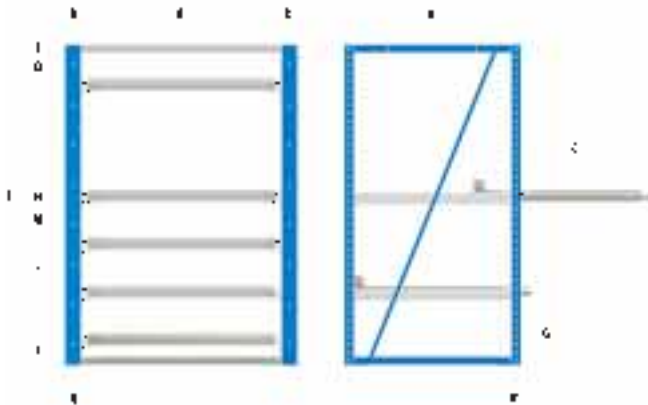
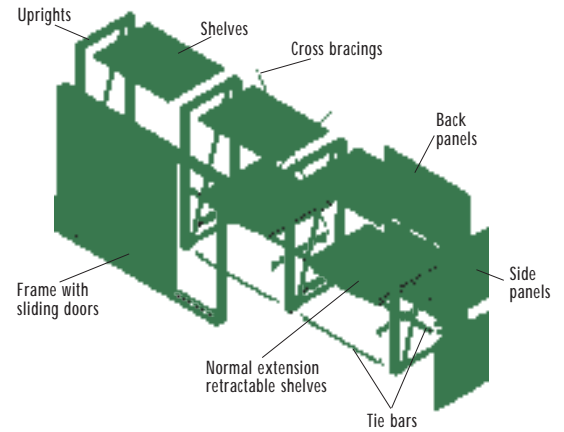

A :	Shelving depth	900, 1100, 1300 mm
B :	Bay width	1250 mm
C :	Retractable extension	600, 750, 900 mm
D :	Upright width	100 mm
E :	Shelving height	1510, 2010, 2210, 2510, 3010 mm
F :	Top shelf	50 mm
G :	Adjustable pitch	50 mm
H :	Retractable shelf thickness	58 mm
I :	Min. distance from floor	185 mm
L :	Min. distance between shelves	300 mm
M :	Min. span between shelves	225 mm
N :	Foot plate	120 mm
O :	Min. distance from top shelf	175 mm
R :	Encumbrance	60 mm
	Upright sheet steel thickness	3 mm

"AR" Shelving System
Technical Data

**FULL
EXTENSION**

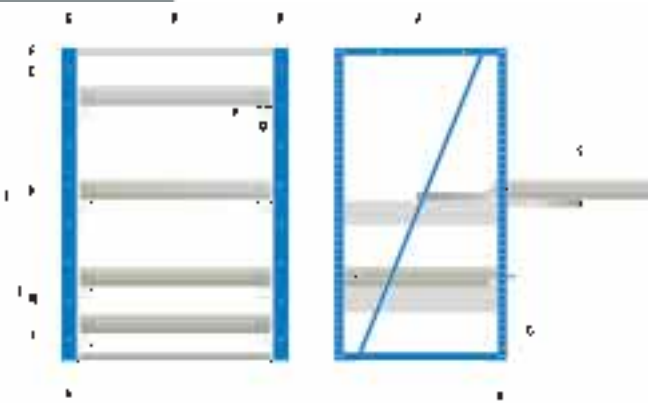
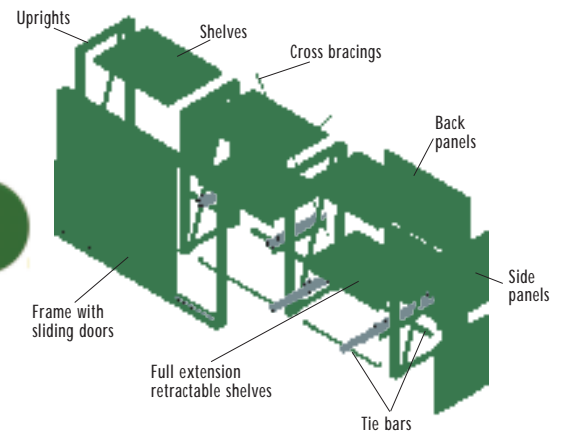

A :	Shelving depth	900, 1100, 1300 mm
B :	Bay width	850, 1050, 1250 mm
C :	Retractable extension	770, 970, 1170 mm
D :	Upright width	100 mm
E :	Shelving height	1510, 2010, 2210, 2510, 3010 mm
F :	Top shelf	50 mm
G :	Adjustable pitch	50 mm
H :	Retractable shelf thickness	107 mm
I :	Min. distance from floor	285 mm
L :	Min. distance between shelves	300 mm
M :	Min. span between shelves	190 mm
N :	Foot plate	120 mm
O :	Min. distance from top shelf	50 mm
P :	Slide height	80 mm
Q :	Slide width	100 mm
R :	Encumbrance	60 mm
	Upright sheet steel thickness	3 mm





RETRACTABLE SHELVING SYSTEM

UPRIGHTS

Slotted on both sides in increments of 50 mm to take top and bottom shelves as well as retractable shelves. The uprights are constructed with welded horizontal and diagonal bracing supports. The foot plate is fitted to secure the shelving system to the floor. Made from high quality sheet steel.

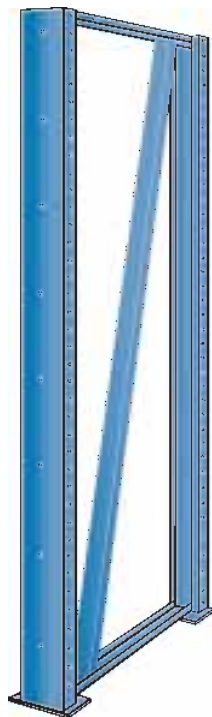

Width mm	Depth mm	Height mm	Order no. blue Ral 5012
100	900	1510	F AR 2050 00 04
		2010	F AR 2060 00 04
		2210	F AR 2070 00 04
		2510	F AR 2080 00 04
		3010	F AR 2090 00 04
100	1100	1510	F AR 2100 00 04
		2010	F AR 2110 00 04
		2210	F AR 2120 00 04
		2510	F AR 2130 00 04
		3010	F AR 2140 00 04
100	1300	1510	F AR 2150 00 04
		2010	F AR 2160 00 04
		2210	F AR 2170 00 04
		2510	F AR 2180 00 04
		3010	F AR 2190 00 04

Colour green Ral 6011 on request.
Code: Order no. 02

FLOOR FIXINGS SET

Extra fixings set for one upright
Order no.
F AG 9214 00 99 galvanized



SINGLE DRAWER OPENING SYSTEM

The single drawer opening system forms a standard part of this shelving system. The system prevents the operator from retracting more than one shelf at any one time. The system comprises a locking bar of the same height as the upright and one locking catch per retractable shelf. Each bay requires one locking bar and one safety catch per retractable shelf.

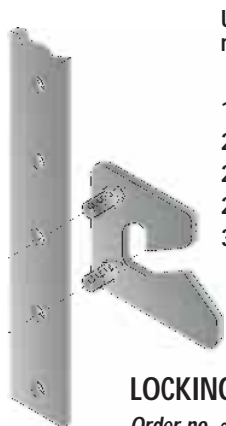

Upright mm	Bar Order no. grey Ral 7000
1510	F AR 1100 00 01
2010	F AR 1110 00 01
2210	F AR 1120 00 01
2510	F AR 1130 00 01
3010	F AR 1140 00 01

Colour green Ral 6011 on request.
Code: Order no. 02

LOCKING CATCH

Order no. grey Ral 7000
F AR 1200 00 01

Colour green Ral 6011 on request.
Code: Order no. 02



RETRACTABLE SHELVING SYSTEM



Colour green Ral 6011 on request.
Code: Order no. 02

RETRACTABLE SHELVES

Width mm	Depth mm	Thickness	Load cap. kg	For bays with normal extension shelves Order no. grey Ral 7000	For bays with full extension shelves Order no. grey Ral 7000
850	900	50	300	-	F AR 4020 00 01
	1100		250	-	F AR 4030 00 01
	1300		200	-	F AR 4040 00 01
1050	900	50	300	-	F AR 4120 00 01
	1100		250	-	F AR 4130 00 01
	1300		200	-	F AR 4140 00 01
1250	900	50	300	F AR 4220 00 01	F AR 4220 00 01
	1100		250	F AR 4230 00 01	F AR 4230 00 01
	1300		200	F AR 4240 00 01	F AR 4240 00 01

Made from sheet steel.
The shelves are bolted to the uprights.



HORIZONTAL DISTANCE TIE BARS

Bay width mm	With normal extension Order no. grey Ral 7000	With full extension Order no. grey Ral 7000
850	-	F AR 1010 00 01
1050	-	F AR 1020 00 01
1250	F AR 1040 00 01	F AR 1030 00 01

The tie bar is bolted to the lower end of the upright.
Two tie bars per bay are required.

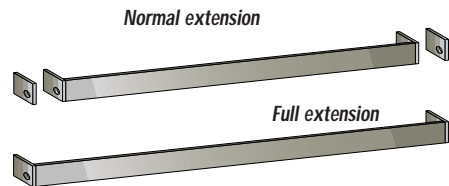

Colour green Ral 6011 on request.
Code: Order no. 02

Attention: if no full extension retractable shelf is positioned within the lower section of the shelving bay, the distance tie bars part no. F AR 1040 00 .. for normal extension shelves must be fitted.

CROSS BRACINGS

Bay width mm	Upright height mm	For bays with normal extension shelves Order no. grey Ral 7000	For bays with full extension shelves Order no. grey Ral 7000
850	1510	-	F AR 1850 00 01
	2010	-	F AR 1860 00 01
	2210	-	F AR 1870 00 01
	2510	-	F AR 1880 00 01
	3010	-	F AR 1890 00 01
1050	1510	-	F AR 1900 00 01
	2010	-	F AR 1910 00 01
	2210	-	F AR 1920 00 01
	2510	-	F AR 1930 00 01
	3010	-	F AR 1940 00 01
1250	1510	F AR 1950 00 01	F AR 1950 00 01
	2010	F AR 1960 00 01	F AR 1960 00 01
	2210	F AR 1970 00 01	F AR 1970 00 01
	2510	F AR 1980 00 01	F AR 1980 00 01
	3010	F AR 1990 00 01	F AR 1990 00 01

Cross bracing are bolted to the rear of the uprights to provide stability.
A cross bracing must be fitted to every 2nd bay.

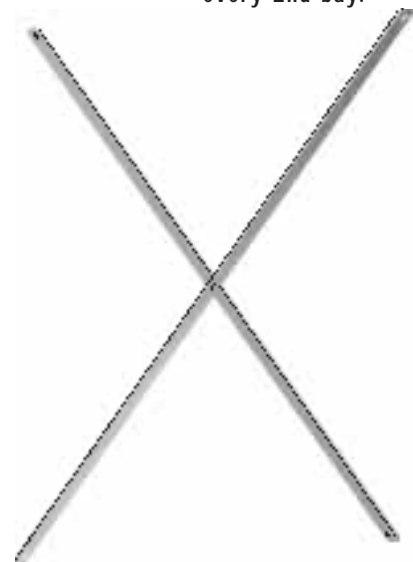

Colour green Ral 6011 on request.
Code: Order no. 02





NORMAL EXTENSION RETRACTABLE SHELVES

Made from high quality sheet steel. The shelves are folded and additional supports are welded to the shelves to achieve maximum strength.
The normal extension guide rails are made from re-inforced steel to increase the steel strength by 20 percent. Each pair of guide rails is fitted with 4 off steel roller bearings. The guide rails are bolted to the uprights and are adjustable in increments of 50 mm.
Max. load capacity 800 kg evenly distributed weight.

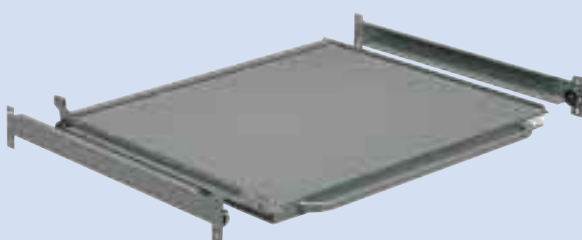

Retractable shelf with 20 H mm upstand on 3 sides



Retractable shelf with 20 H mm upstand on all 4 sides

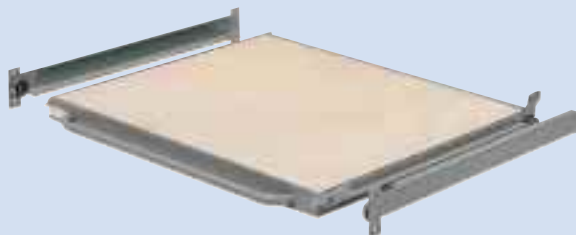

Retractable shelf with 20 H mm upstand on all 4 sides, fitted with Multiplex wood cover 12 mm thick

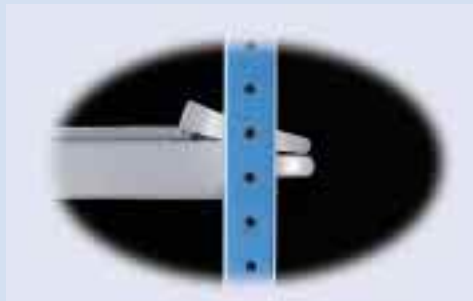

LOCK-IN/LOCK-OUT SYSTEM

A safety catch secures the shelf in normal and retracted position.

TECHNICAL DATA FOR NORMAL EXTENSION RETRACTABLE SHELVES

- P : Usable depth of shelves 800, 1000, 1200 mm
- Q : Usable width of shelves 1160 mm
- H : Shelf thickness 58 mm
- C : Extension to 600, 750, 900 mm

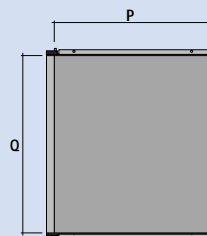

Load capacity of retractable shelves
800 kg E.D.L.

Bay width mm	Shelf depth mm	Usable width mm	Usable depth mm	Extension to mm	Load cap. kg	Shelf with 3-sided upstand Order no. grey Ral 7000	Shelf with 4-sided upstand Order no. grey Ral 7000	Shelf with wooden top Order no. grey Ral 7000
	900		800	600		F AR 6600 00 01	F AR 6650 00 01	F AR 6650 01 01
1250	1100	1160	1000	750	800	F AR 6610 00 01	F AR 6660 00 01	F AR 6660 01 01
	1300		1200	900		F AR 6620 00 01	F AR 6670 00 01	F AR 6670 01 01



FULL EXTENSION RETRACTABLE SHELVES

Made from high quality sheet steel. The shelves are folded and additional supports are welded to the shelves to achieve maximum strength. The telescopic guide rails are made from re-inforced steel to increase the steel strength by 20 percent. Each pair of telescopic guide rails is fitted with 14 off high performance steel roller bearings and 12 supporting roller bearings. The guide rails are bolted to the uprights and are adjustable in increments of 50 mm. Max. load capacity 1000 kg evenly distributed weight.



Retractable shelf with 20 H mm upstand on 3 sides



Retractable shelf with 20 H mm upstand on all 4 sides



Retractable shelf with 20 H mm upstand on all 4 sides, fitted with Multiplex wood cover 12 mm thick



LOCK-IN/LOCK-OUT SYSTEM

A safety catch secures the shelf in normal and retracted position.

TECHNICAL DATA FOR FULL EXTENSION RETRACTABLE SHELVES

- P : Usable depth of shelves 845, 1045, 1245 mm
- Q : Usable width of shelves 805, 1005, 1205 mm
- H : Shelf thickness 107 mm
- C : Extension to 770, 970, 1170 mm

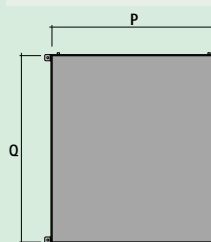

Load capacity of retractable shelves
1000 kg E.D.L.

Bay width mm	Shelf depth mm	Usable width mm	Usable depth mm	Extension to mm	Load cap. kg	Shelf with 3-sided upstand Order no. grey Ral 7000	Shelf with 4-sided upstand Order no. grey Ral 7000	Shelf with wooden top Order no. grey Ral 7000
850	900	805	845	770	1000	F AR 7400 00 01	F AR 7450 00 01	F AR 7450 01 01
	1100		1045	970	1000	F AR 7410 00 01	F AR 7460 00 01	F AR 7460 01 01
	1300		1245	1170	1000	F AR 7420 00 01	F AR 7470 00 01	F AR 7470 01 01
1050	900	1005	845	770	1000	F AR 7500 00 01	F AR 7550 00 01	F AR 7550 01 01
	1100		1045	970	1000	F AR 7510 00 01	F AR 7560 00 01	F AR 7560 01 01
	1300		1245	1170	1000	F AR 7520 00 01	F AR 7570 00 01	F AR 7570 01 01
1250	900	1205	845	770	1000	F AR 7600 00 01	F AR 7650 00 01	F AR 7650 01 01
	1100		1045	970	1000	F AR 7610 00 01	F AR 7660 00 01	F AR 7660 01 01
	1300		1245	1170	1000	F AR 7620 00 01	F AR 7670 00 01	F AR 7670 01 01

Colour green Ral 6011 on request.
Code: Order no. 02



SIDE PANELS

Made from sheet steel
and bolted to the uprights.

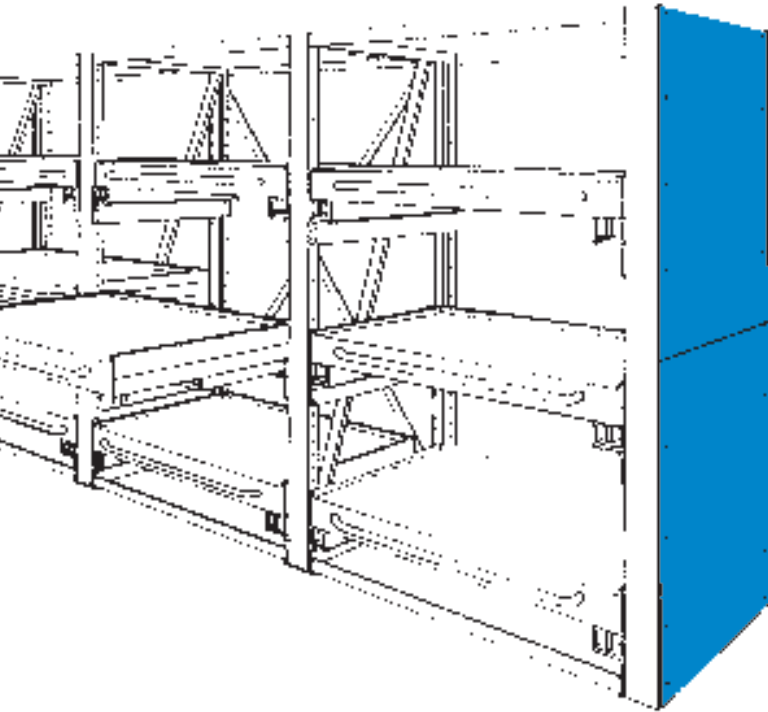

Shelving depth mm	Shelving height mm	Side panels required q.ty of sections	Order no. blue Ral 5012
900	1510	1	F AR 1250 00 04
	2010	2	F AR 1260 00 04
	2210	2	F AR 1270 00 04
	2510	2	F AR 1280 00 04
	3010	2	F AR 1290 00 04
1100	1510	1	F AR 1300 00 04
	2010	2	F AR 1310 00 04
	2210	2	F AR 1320 00 04
	2510	2	F AR 1330 00 04
	3010	2	F AR 1340 00 04
1300	1510	1	F AR 1350 00 04
	2010	2	F AR 1360 00 04
	2210	2	F AR 1370 00 04
	2510	2	F AR 1380 00 04
	3010	2	F AR 1390 00 04

Colour green Ral 6011 on request.
Code: Order no. 02





BACK PANELS

Made from sheet steel and bolted to the uprights.

Bay width mm	Shelf height mm	Back panel required q.ty sections	For bays with normal extension shelves Order no. grey Ral 7000	For bays with full extension shelves Order no. grey Ral 7000
850	1510	1	–	F AR 1450 00 01
	2010	2	–	F AR 1460 00 01
	2210	2	–	F AR 1470 00 01
	2510	2	–	F AR 1480 00 01
	3010	2	–	F AR 1490 00 01
1050	1510	1	–	F AR 1500 00 01
	2010	2	–	F AR 1510 00 01
	2210	2	–	F AR 1520 00 01
	2510	2	–	F AR 1530 00 01
	3010	2	–	F AR 1540 00 01
1250	1510	1	F AR 1550 00 01	F AR 1550 00 01
	2010	2	F AR 1560 00 01	F AR 1560 00 01
	2210	2	F AR 1570 00 01	F AR 1570 00 01
	2510	2	F AR 1580 00 01	F AR 1580 00 01
	3010	2	F AR 1590 00 01	F AR 1590 00 01

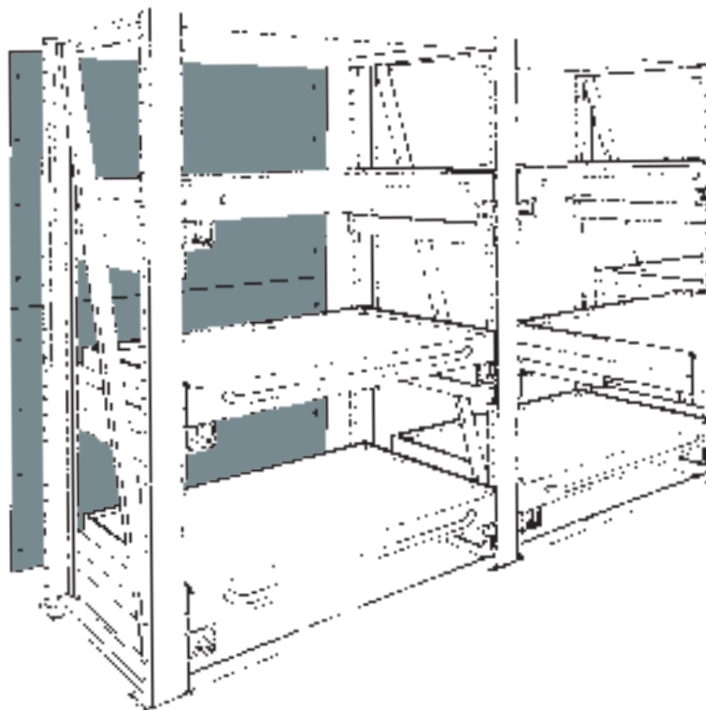

Colour green Ral 6011 on request.
Code: Order no. 02





SLIDING DOORS

Sliding doors are fitted with safety cylinder locking mechanism and are fitted to the face of the shelving system. One set of doors locks 2 bays of shelving. The doors have double folded edges, are reinforced and run on roller bearings. Made from high quality sheet steel.

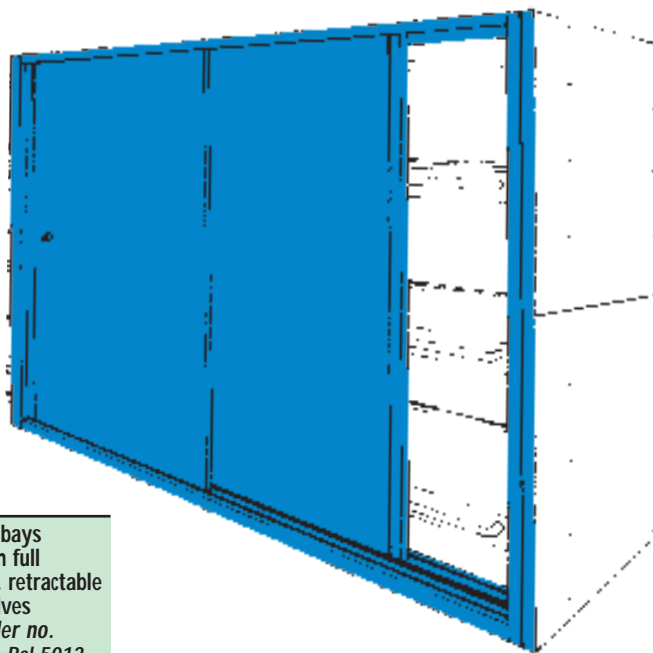

Bay width mm	Shelving width mm	Shelving height mm	Shelf thickness mm	For bays with normal ext. retractable shelves Order no. blue Ral 5012	For bays with full ext. retractable shelves Order no. blue Ral 5012
850	1900	1510	165	-	F AR 5000 00 04
		2010	165	-	F AR 5050 00 04
		2210	165	-	F AR 5100 00 04
		2510	165	-	F AR 5150 00 04
		3010	165	-	F AR 5200 00 04
1050	2300	1510	165	-	F AR 5250 00 04
		2010	165	-	F AR 5300 00 04
		2210	165	-	F AR 5350 00 04
		2510	165	-	F AR 5400 00 04
		3010	165	-	F AR 5450 00 04
1250	2700	1510	165	F AR 5500 00 04	F AR 5500 00 04
		2010	165	F AR 5550 00 04	F AR 5550 00 04
		2210	165	F AR 5600 00 04	F AR 5600 00 04
		2510	165	F AR 5650 00 04	F AR 5650 00 04
		3010	165	F AR 5700 00 04	F AR 5700 00 04

Colour green Ral 6011 on request.
Code: Order no. 02

